

Installation Guidelines

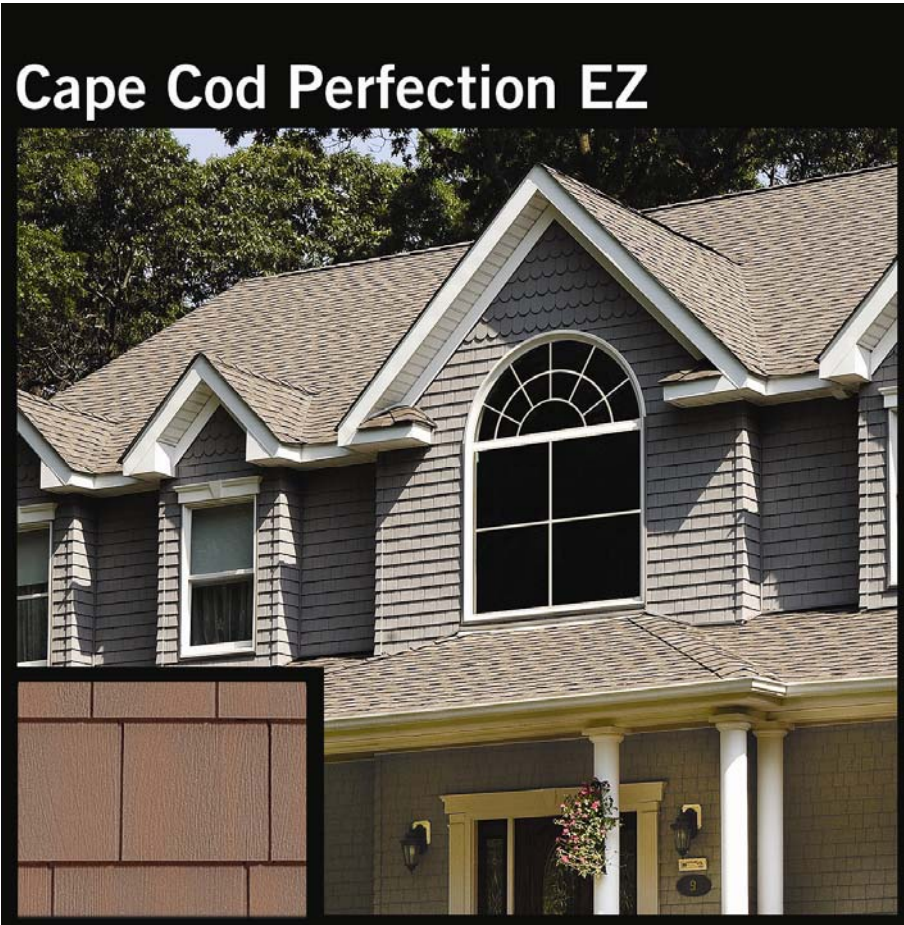

Exteria Building Products provides these instructions as general guidelines only. Exteria Building Products neither installs siding nor has any control over any installation. The contractor and/or installer shall be responsible for ensuring that all applicable local building codes are followed, which may require modification of these general guidelines. Exteria Building Products assumes no liability for personal injury or property damage resulting from improper or careless application of the described techniques.

For more information on Exteria Building Products and its wide variety of state-of-the-art products, please call us at 877 – EXTERIA (877-398-3742) or write: 1111 NW 165 Street, Miami, FL 33169-5819. Installation Guidelines can be downloaded from our website: www.exteriapb.com.

BASIC GUIDELINES

1. Always work from left to right installing one row at a time, and completing one wall before beginning another. Always start at the lowest point of the structure.
2. As with any composite plastic exterior building materials, Exteria Building Products panels will expand and contract with a change in temperature. Therefore, during installation it is necessary to position the panels properly to compensate for temperature effects. Note that the average spacing between shingle seams within a panel is approximately 3/16". If the temperature is about 30 degrees F, position the panels on the 30 degree spacing guide mark to allow for expansion in warmer weather. If the temperature is nearer to 60 degrees F, position panel on 60 degree spacing guide mark thereby allowing for both expansion and contraction as the temperature changes. If the temperature is closer to 90 degrees F, position the panel on the 90 degree spacing guide mark to allow for contraction in colder temperatures. Use caution not to force panels down onto the flange of the lower row, as this will override the expansion joints and may cause buckling. Storing panels in heated areas make them more pliable, allowing for easier installation in colder temperatures.

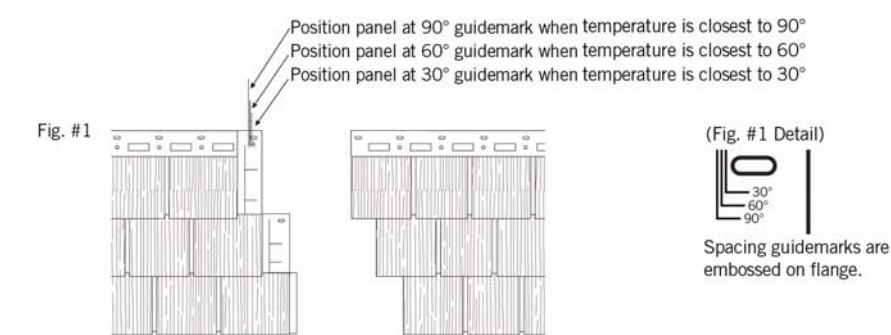

3. Store panels on edge, do not stack flat.
4. After positioning the panel at the proper spacing for the installation temperature, install a nail or fastener in the center hole of the panel. By attaching a fastener through the center hole, the panel will move evenly in both directions from the center out (Figure 2).

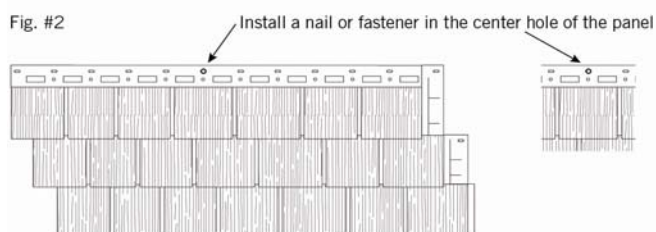

5. If the panel is a partial panel used at either end, a new center hole should be created, by drilling at 1/8" hole in the top flange, near the center of the panel at the same height as the other installation holes (Figure 3).

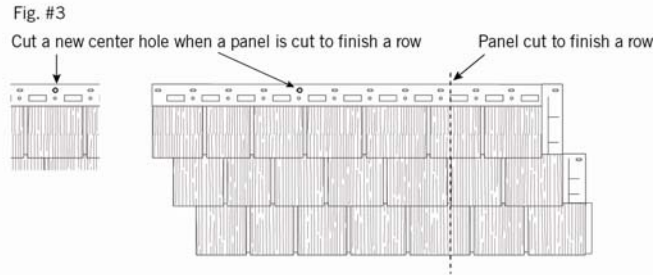

6. Exteria panels are intended for use in a vertical placement only, and are not designed or warranted for roofing or flooring applications. Mansard roofs with a 45/12 slope or greater are acceptable applications.
7. It is essential that you work over a smooth, flat, nailable wall surface, (i.e., Minimum 7/16" OSB board or plywood is recommended). Refer to the respective furring strip installation guidelines if furring strips are utilized.
8. Non-corrosive fasteners are required to secure the panels and they must penetrate the solid substrate by at least 7/16".
9. If face nailing is employed, pre-drill a hole in an inconspicuous area, such as a shingle seam. The hole must be larger than the shank of the nail or screw, but smaller than the head, to allow for possible expansion. The head can be covered with matching paint.
10. Fastening the panels should not restrict panel movement. Fasteners should be driven straight into the center of any elongated hole making light contact with the panel, allowing the panel to be hung. It is best to work with the panels at waist-level, allowing the installer to inspect the back of the panels, verifying that all fingers are properly engaged.
11. Do not install all corners at one time, or you will lose the ability to adjust and properly align them to the panels. It is recommended to not install more than two corners at a time.
12. Siding has always been designed as an exterior cladding, not a weather resistant barrier. Exteria siding is designed to allow the material underneath it to breathe; therefore, it is not a watertight covering. To achieve designed performance, Exteria siding must be installed over a weather resistant house barrier system such as house wrap.

INSTALLATION STEPS

STEP ONE Install the starter strip at the lowest point of the structure. The structure's solid substrate must be no less than 7/16" thick. The strip should be positioned 3" from the wall corner allowing for the width of the corner piece. Nail the starter strips every 12" ensuring that the starter strip remains level (Figure 4). A chalk line is recommended.

Fig. #4

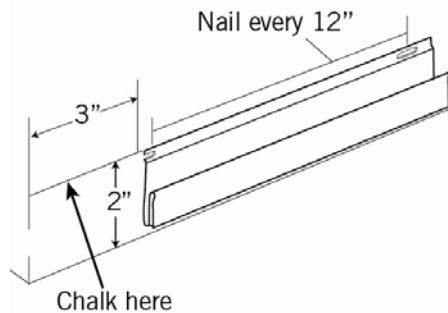

STEP TWO It is recommended to determine the number of panels needed for the wall by measuring the total length of the wall in inches, subtracting the width of the corner pieces used and dividing by 38" (the width of one panel exposed to the weather). As you will need to cut the end panel, ensure that it remains at least 12" wide by reducing the size of the starting panel. For best results, cut the panel on the "A" cut line, with the second cut on "C", and the third on "B" to avoid vertical seam overlap and to eliminate repeating patterns (Figure 5). Following the specified A, B, C cutting line order on succeeding rows will provide an authentic and random shingle appearance. However, if you choose an alternate cutting location you must be careful not to create any vertical seam overlap. Do not cut more than one end piece at a time since adjustments may be required for succeeding rows.

Fig. #5

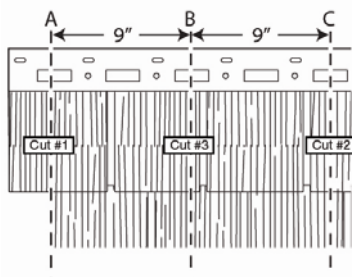

Panels must first be cut on "A" cut line, with the second cut on "C", and the third on "B" to avoid vertical seam overlap and to break up repeating pattern.

STEP THREE Work from left to right. If a matching 28" Cape Cod Perfection EZ corner is used, it must be properly aligned with the first panel to start the row. This is accomplished by first loosely installing the corner so that it will align horizontally with the first cut panel (Figure 6).

Fig. #6

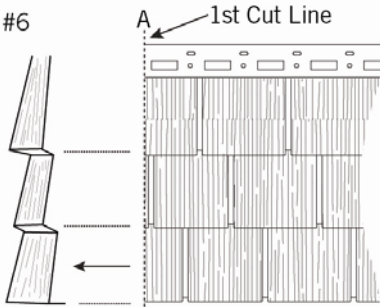

Slide cut-to-fit panel next to corner

Using your right hand, temporarily position the first cut panel on the starter strip about 3" from the left edge of the wall. With the left hand, hold the corner so that it is properly aligned with the panel. Still holding the corner in place, remove the panel and install a fastener loosely into the center of the elongated hole located in the middle of the corner piece. Reposition the panel again, but this time slide the corner up or down along the elongated hole until it is properly aligned with the first cut panel, then permanently mount the corner with fasteners in the remaining holes. Now permanently install the first panel by properly spacing the panel. Install a fastener into the center hole and fasten per Step Six.

STEP FOUR: For all succeeding panels of the present row, simply position the panel approximately 2 inches below the previous panel and slide upward (Figure 7) making sure to engage the two side locking tabs and bottom locking rail. Once engaged, gently tap the panel into place with the palm of your hand. Use the proper spacing guide marks (Figure 1) to ensure the correct seam spacing between panels.

Fig. #7

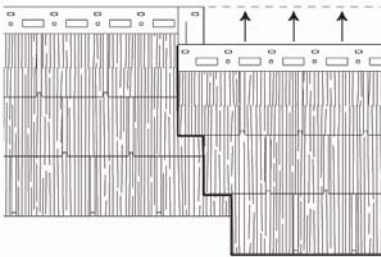

Slide upward making sure to engage the two locking clips and the bottom locking rail.

STEP FIVE: By attaching a fastener into the center of any elongated hole on the top flange of the panels, you will have the flexibility to move the panels to adjust the shingle seam per Step Four in the basic guidelines above. This will also make it easier to install the end piece, either into a J-channel or corner post.

STEP SIX: Exteria provides positive stop posts which are 1/8" below the top edge of installation fingers. Do not force the panels beyond the stop posts when installing succeeding rows of panels. The stops are designed to prevent buckling due to changing temperatures (Figure 8). The panel requires a minimum of seven fasteners per panel as shown (Figure 9). A closer spacing of fasteners is required for

high velocity wind areas; for details refer to report ESR-3070, which can be downloaded from our website www.exteriabp.com. The fasteners must be installed into a solid substrate of no less than 7/16" thick.

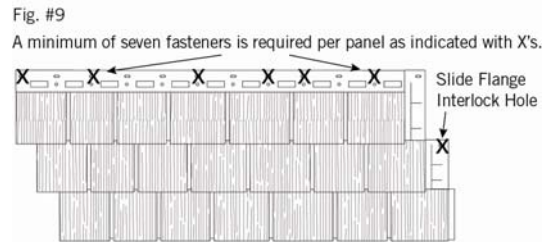
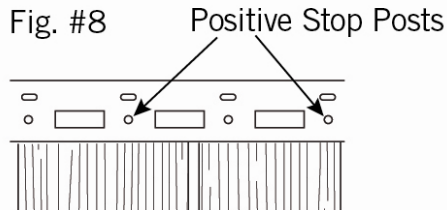

When attaching the fasteners, be sure they only lightly touch the panel allowing it to move with varying temperatures. The fastener must be installed flush with the panel, so as not to interfere with the succeeding row of panels. Note: The installation holes on the side flange are recessed. When fastening in these recessed areas, be sure the head of the fastener is level with or below the top surface of the panel. Be careful not to secure the fastener too tightly giving the panel the ability to expand and contract in varying temperatures.

STEP SEVEN Note that the average spacing between shingle seams within a panel is approximately 3/16". If the temperature is about 30 degrees F, position the panels on the 30 degree spacing guide mark to allow for expansion in warmer weather. If the temperature is about 60 degrees F, position the panels on the 60 degree spacing guide mark to allow for both expansion and contraction. If the temperature is about 90 degrees F, position the panels on the 90 degree spacing guide mark to allow for contraction in colder weather (See Figure 1).

Note: Allow 1/8" spacing around all openings for installation around 30 degrees F. Once the panel has been properly spaced, insert a fastener into the center hole of the panel.

STEP EIGHT When completing a wall and a partial panel is used, remember to drill a new center hole and if face nailing is required, refer to Basic Guideline # 9. Start each successive row by cutting the panels at either the "A", "B", or "C" cut lines located on the top flange of the panels (Figure 5). Cutting the panels at the cut lines will avoid vertical seam overlap. Randomly choosing between the three available cutting lines will provide a pleasing and natural appearance and avoid potential repeating patterns on a wall. Step Two suggests cutting order (A, C, B). Be sure the right end piece of the row is no less than 12" wide.

STEP NINE Exteria J-channels may be used for inside corner treatments (Figures 10 and 11). It is recommended to sleeve the corner with vinyl or aluminum coil prior to installation of panels.

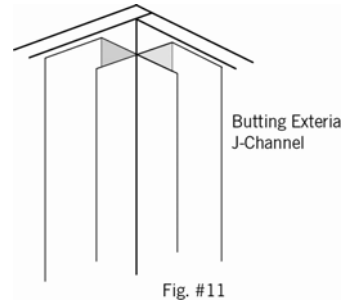
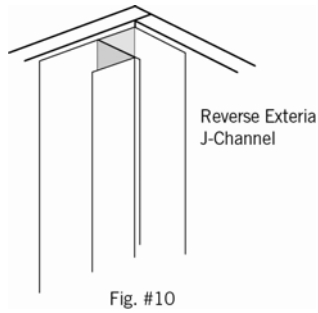

STEP TEN When continuing a course that has been cut to go above a window or doorway, the upward installation method described in Step Four may not be possible. In this case, it may be necessary to notch the side flange of the panel to allow the adjacent panel to slide into it from right to left (Figure 12) rather than the normal upward motion.

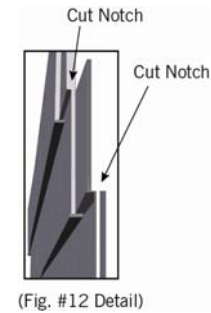
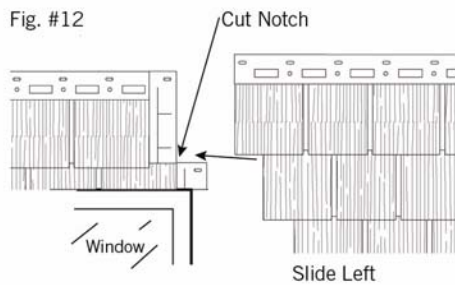

REMINDERS:

Some adjustment may need to be made at the vertical overlap of two corners (as they are installed) in order to maintain the corner/panel horizontal alignment. There is approximately a 1/2" vertical adjustment available.

Fitting panels between windows or around openings requires a cut-back spacing of approximately 1/8" to allow for product expansion.

ATTACHING OBJECTS TO PANELS

Never attach fixtures directly to Exteria siding. When attaching fixtures, use a block and follow the fixture manufacturer's installation instructions.

SPECIAL SITUATIONS AND SUGGESTIONS

SITUATION

1. Panels won't lock together side to side
2. The bottom locking fingers won't lock into the previous row.
3. Panels are buckling on the wall.
4. Panels are not laying down flat.

ITEMS TO CHECK

The wall may not be level and flat. Check previous panels to ensure that all panels and installation fingers are properly seated. (See Basic Guidelines)

Make sure the nails are not restricting panel movement. Make sure all fingers are engaged into corresponding rails.